

Forces and magnets

A force is a push, a pull or a twist.

Forces can have the following effects:

- Start an object moving.
- Change the direction of a moving object.
- Speed a moving object up.
- Stop an object from moving.
- Slow a moving object down.
- Change the shape of an object.

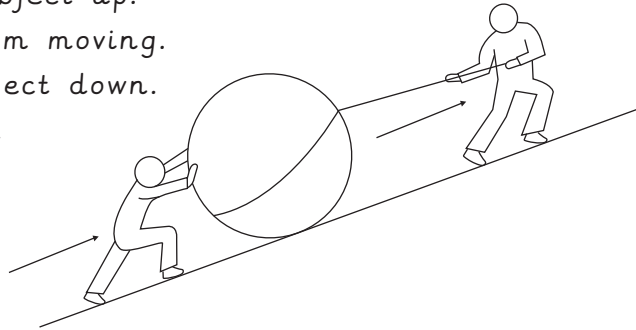

Contact forces are caused by contact between two surfaces.

Friction is a contact force that acts between surfaces that are sliding over one another.

It acts in the opposite direction to motion.

The rougher a surface is, the more bumps it has and the more points of contact there are between the two surfaces. More points of contact create more friction. More friction leads to a greater slowing effect on the object.

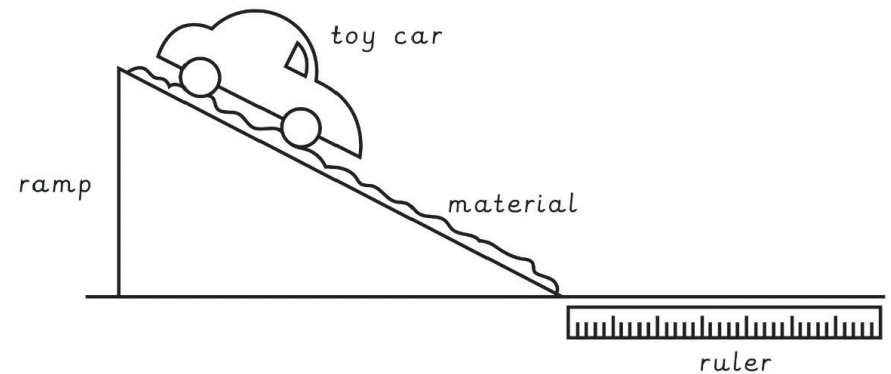

Friction is useful when it:

- Helps a car brake.
- Lights a match.
- Rubs out mistakes.
- Opens a jar.
- Brushes teeth clean.
- Sands down wood.

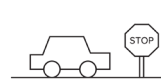

car braking



brushing your teeth

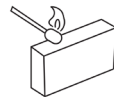

lighting a match



rubbing out

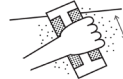

sanding



opening a jar

Friction is not useful when it:

- Slows down a racing car.
- Wears down car or bike tyres.

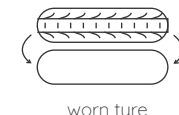

worn tyre



breaking speed records

Forces and magnets

Non-contact forces can act at a distance.

Examples of non-contact forces are:

- Magnetism.
- Gravity.

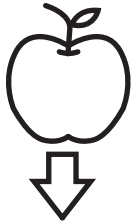

gravity



magnetism

Magnets are used in compasses, fridge magnets, toys, jewellery, handbags, furniture, paints and polishes.

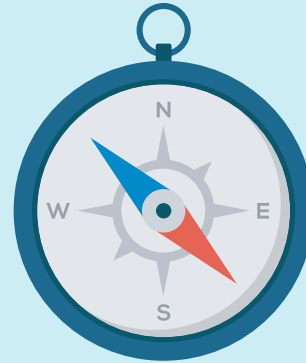

Magnetism is the non-contact force that comes from a magnet.



north pole

south pole

Magnets have a **north pole** and a **south pole**. The opposite poles of magnets attract and like poles repel.



There are different types of magnets. They can have different strengths.

bar magnet



horseshoe magnet



ring magnet



button magnet



Electromagnets are magnets that can be turned on and off using electricity.

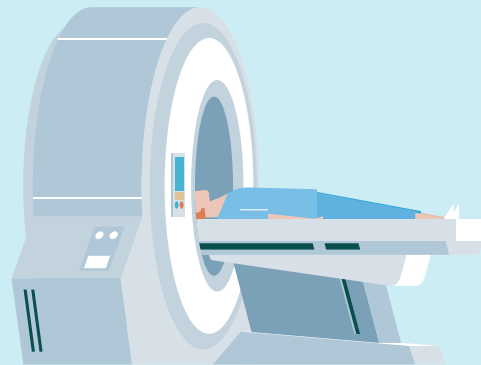

They are used in doorbells, speakers, motors, Maglev trains, MRIs and on cranes.

Magnetic materials are attracted to a magnet. Iron and nickel are magnetic metals. Objects that contain them will be attracted to a magnet.